

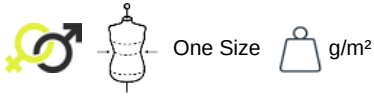

KP891

## Berretto con patch e fodera Thinsulate riciclato

50% Poliestere riciclato e 50% Acrilico. Berretto a maglia con risvolto. Fodera termica super-confort in Thinsulate. Patch frontale in cotone per una facile personalizzazione. Etichetta con il nome della marchio staccabile.



### Informazioni complementari

#### Logistica



CN - Cina



CN - Cina

#### Codice doganale



65050090

#### Istruzioni di lavaggio





KP891

## Berretto con patch e fodera Thinsulate riciclato

## Dimensioni

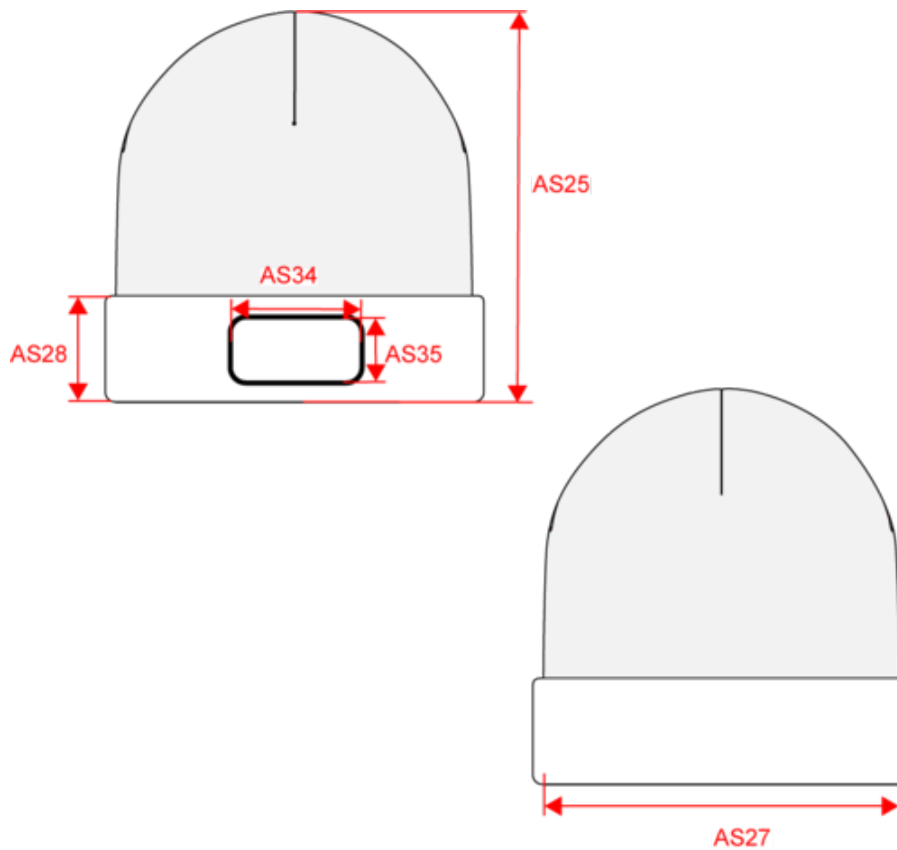











Measurements in cm	One size
AS25 - Total height at the highest level	22.50
AS27 - 1/2 bottom width	21.00
AS28 - Turn up height	8.00
AS34 - Patch length	10.00
AS35 - Patch height	5.00



KP891

## Berretto con patch e fodera Thinsulate riciclato

## Informazioni colori

 <b>Black</b> RVB : 35,35,37 Pantone C : Black Pantone TCX : 19-4004TCX	 <b>Dark Grey</b> RVB : 63,60,60 Pantone C : 447C Pantone TCX : 19-0000TCX	 <b>Dark Khaki</b> RVB : 75,71,61 Pantone C : 418C Pantone TCX : 19-0414TCX	 <b>Forest Green</b> RVB : 41,62,48 Pantone C : 5605C Pantone TCX : 19-5918TCX	 <b>Grey Heather</b> RVB : Pantone C : Based on 417C Pantone TCX : Based on 18-5203TCX
 <b>Navy</b> RVB : 41,46,56 Pantone C : 433C Pantone TCX : 19-4012TCX	 <b>Oxford grey</b> RVB : 155,155,162 Pantone C : Cool gray 7C Pantone TCX : 16-3850TCX	 <b>Red</b> RVB : 195,32,54 Pantone C : 200C Pantone TCX : 19-1664TCX	 <b>Royal Blue</b> RVB : 33,59,127 Pantone C : 7687C Pantone TCX : 19-3952TCX	 <b>White</b> RVB : 236,236,252 Pantone C : White Pantone TCX : 11-0601TCX

 Logistica  25  100

Sizes	Width (cm)	Height (cm)	Length (cm)	Net weight (kg)	Gross weight (kg)	Pieces/Box	Pieces/Bundle
One Size	42.00	25.00	60.00	6.40000	7.30000	100	0